

CETOP VALVES

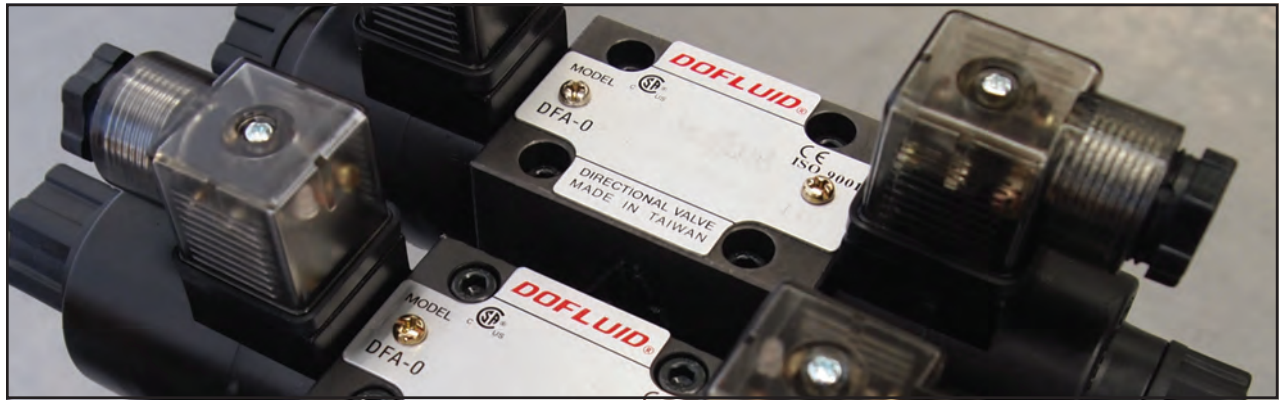



SAMT

H Y D R A U L I C S

CETOP VALVES

CONTENTS

SOLENOID OPERATED VALVES

HANDLE, PNEU & HYD OPERATED VALVES

MODULAR VALVES









MANIFOLDS & SUBPLATES

QUICK HITCH PICTURES

CETOP SOLENOID VALVES DOFLUID



Cetop 3: Flow 80 LPM, Pressure 350 Bar

Part Number & Pricing		Specifications	
Voltage Options DC12, DC24, AC110, AC240	List Price	Schematic	Weight Kg
DFA 02-3C2- Voltage -L-35	\$ 195		2
DFA 02-3C4- Voltage -L-35	\$ 195		2
DFA 02-3C60- Voltage -L-35	\$ 210		2
DFA 02-3C3- Voltage -L-35	\$ 195		2
DFA 02-2B2- Voltage -L-35	\$ 160		1.5
DFA 02-2B2B- Voltage -L-35	\$ 160		1.5
DFA 02-2B4B- Voltage -L-35	\$ 160		1.5
DFA 02-2B60BL- Voltage -L-35	\$ 170		1.5
DFA 02-2B3B- Voltage -L-35	\$ 160		1.5

Parts

Part.	Description	List Price
DC3 - Coil (Voltage)	Coil Only	\$ 52
DC3 - Armiture	Armiture Only	\$ 52
Z4L	Electrical Plug with LED	\$ 15

Front & Side View - 12 / 24 Volt DC
DFA-02-...-DC...-L-35 Series

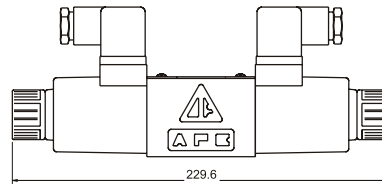



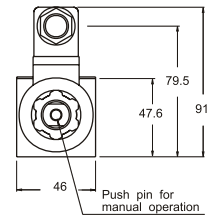



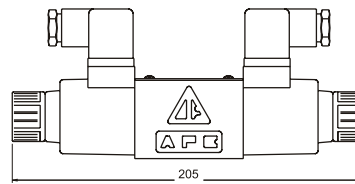

End View - DC & AC



Front & Side View - 110 / 240 Volt AC
DFA-02-...-AC...-L-35 Series



Cetop 5: Flow 160 LPM, Pressure 350 Bar

Part Number & Pricing		Specifications	
Voltage Options DC12, DC24, AC110, AC240	List Price	Schematic	Weight Kg
DFA 03-3C2- Voltage -L-35	\$ 294		5.1
DFA 03-3C4- Voltage -L-35	\$ 294		5.1
DFA 03-3C60- Voltage -L-35	\$ 315		5.1
DFA 03-3C3- Voltage -L-35	\$ 294		5.1
DFA 03-2B2- Voltage -L-35	\$ 240		4
DFA 03-2B2B- Voltage -L-35	\$ 240		4
DFA 03-2B4B- Voltage -L-35	\$ 240		4
DFA 03-2B60BL- Voltage -L-35	\$ 255		4
DFA 03-2B3B- Voltage -L-35	\$ 240		4

Parts

Part.	Description	List Price
DC5 - Coil (Voltage)	Coil Only	\$ 68
DC5 - Armiture	Armiture Only	\$ 68
Z4L	Electrical Plug with LED	\$ 15

Side View - 12 / 24 Volt DC
DFA-03-...-DC...-L-35 Series

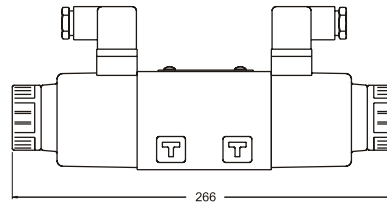

End View - DC & AC

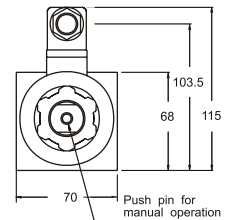

Side View - 110 / 240 Volt AC
DFA-03-...-AC...-L-35 Series

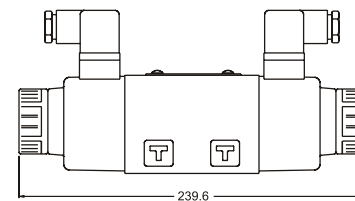

CETOP SOLENOID VALVES

Cetop 3: Flow 80 LPM, Pressure 320 Bar



Part Number & Pricing		Specifications	
Voltage Options G12, G24, AG110, AG240	List Price	Schematic	Weight Kg
4WE6E75/ Voltage NZ4	\$ 175		2.1
4WE6J75/ Voltage NZ4	\$ 175		2.1
4WE6G75/ Voltage NZ4	\$ 185		2.1
4WE6H75/ Voltage NZ4	\$ 175		2.1
4WE6D75/ Voltage NZ4	\$ 135		1.6
4WE6EA75/ Voltage NZ4	\$ 135		1.6
4WE6JA75/ Voltage NZ4	\$ 135		1.6
4WE6GA75/ Voltage NZ4	\$ 140		1.6
4WE6HA75/ Voltage NZ4	\$ 135		1.6

Parts

Part.	Description	List Price
IC3 - Coil (Voltage)	Coil Only	\$ 52
IC3 - Armature	Armature Only	\$ 52
Z4L	Electrical Plug with LED	\$ 15

Front & Side View - 12 / 24 Volt DC
4WE6...75/DC...NZ4 Series

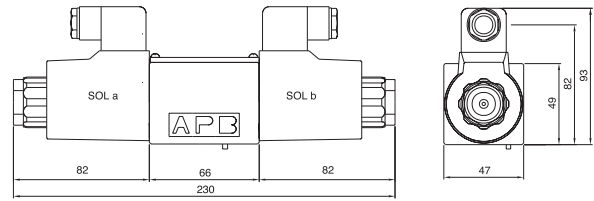

Front & Side View - 110 / 240 Volt AC
4WE6...75/AC...NZ4 Series

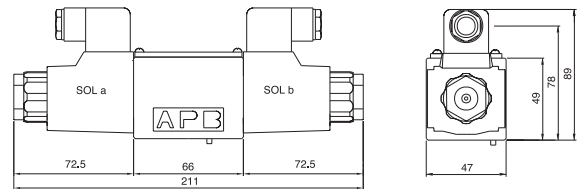

Cetop 5: Flow 160 LPM, Pressure 320 Bar

Part Number & Pricing		Specifications	
Voltage Options G12, G24, AG110, AG240	List Price	Schematic	Weight Kg
4WE10E23/ Voltage NZ4	\$ 265		5.5
4WE10J23/ Voltage NZ4	\$ 265		5.5
4WE10G23/ Voltage NZ4	\$ 284		5.5
4WE10H23/ Voltage NZ4	\$ 265		5.5
4WE10D23/ Voltage NZ4	\$ 211		4.5
4WE10EA23/ Voltage NZ4	\$ 211		4.5
4WE10JA23/ Voltage NZ4	\$ 211		4.5
4WE10GA23/ Voltage NZ4	\$ 226		4.5
4WE10HA23/ Voltage NZ4	\$ 211		4.5

Parts

Part.	Description	List Price
IC5 - Coil (Voltage)	Coil Only	\$ 68
IC5 - Armature	Armature Only	\$ 68
Z4L	Electrical Plug with LED	\$ 15

Front & Side View - 12 / 24 Volt DC
4WE10...23/DC...NZ4 Series

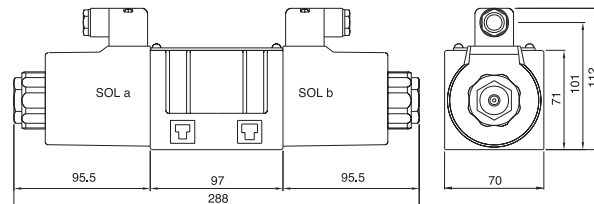

Front & Side View - 110 / 240 Volt AC
4WE10...23/AC...NZ4 Series

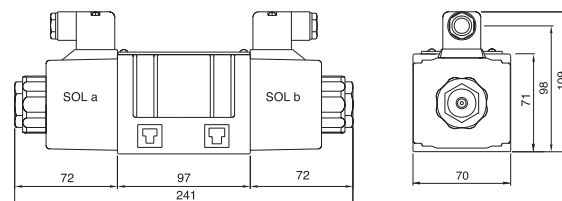

Cetop 7: Flow 300 LPM, Pressure 320 Bar

Part Number & Pricing		Specifications	
Voltage Options G12, G24, AG110, AG240	List Price	Schematic	Weight Kg
4WE16E53/ Voltage NZ4	\$ 675		9.7
4WE16J53/ Voltage NZ4	\$ 675		9.7
4WE16G53/ Voltage NZ4	\$ 729		9.7
4WE16H53/ Voltage NZ4	\$ 675		9.7
4WE16D53/ Voltage NZ4	\$ 639		8.7

Parts

Part.	Description	List Price
C7-P4.5	P Port Check - 4.5 Bar	\$ 130

Front & Side View - Mainstage and Pilot
4WE16...53/.....NZ4

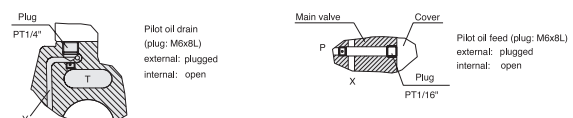
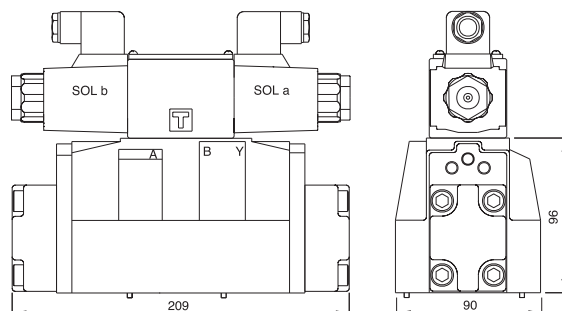

CETOP SOLENOID VALVES

Cetop 8: Flow 450 LPM, Pressure 320 Bar



Part Number & Pricing		Specification	
Voltage Options G12, G24, AG110, AG240	List Price	Scheme	Weight Kg
4WE22E53/ Voltage NZ4	\$ 909		14.6
4WE22J53/ Voltage NZ4	\$ 909		14.6
4WE22G53/ Voltage NZ4	\$ 954		14.6
4WE22H53/ Voltage NZ4	\$ 909		14.6
4WE22D53/ Voltage NZ4	\$ 850		13.2

Parts

Part.	Description	List Price
C8-P4.5	P Port Insert Check - 4.5bar	\$ 145

Front & Side View - Mainstage and Pilot
4WE22...53/.....NZ4

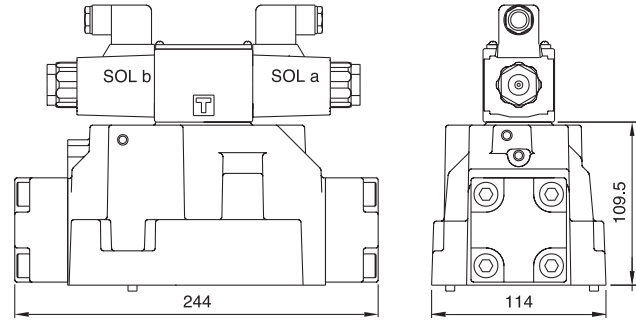

Pilot oil feed (plug: M6x8L)
external: plugged
internal: open
Pilot oil drain (plug: M6x8L)
external: plugged
internal: open

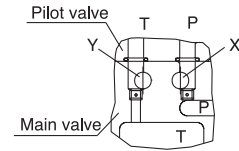

SPOOL IDENTIFICATION TABLE

SCHEMES

Graphic symbols for 3- position directional spool valves



Graphic symbols for 2- position directional spool valves

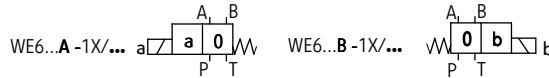

Graphic symbols for spools

working and indirect positions	working positions	working and indirect positions	working positions	working and indirect positions	working positions

CETOP VALVES HANDLE, PNEUMATIC & HYDRAULIC



Handle Operated Valves: Cetop 3, Flow 60 LPM, Pressure 320 Bar

Part Number & Pricing		Specifications	
Spring Return	List Price	Schematic	Weight Kg
4WMM6E51	\$ 286		1.6
4WMM6J51	\$ 286		1.6
4WMM6G51	\$ 286		1.6
4WMM6H51	\$ 286		1.6
4WMM6D51	\$ 286		1.6

Part Number & Pricing		Specifications	
Detent	List Price	Schematic	Weight Kg
4WMM6E51F	\$ 286		1.6
4WMM6J51F	\$ 286		1.6
4WMM6G51F	\$ 286		1.6
4WMM6H51F	\$ 286		1.6
4WMM6D51F	\$ 286		1.6

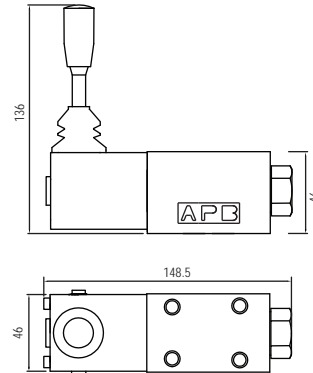

Pneumatic Operated Valves: Cetop 3, Flow 60 LPM, Pressure 320 Bar

Part Number & Pricing		Specifications	
Cetop 3	List Price	Schematic	Weight Kg
RH06016F	\$ 350		1.9
RH06046F	\$ 350		1.9
RH06026F	\$ 350		1.9
RH06006F	\$ 350		1.9
RH06116F	\$ 300		1.5

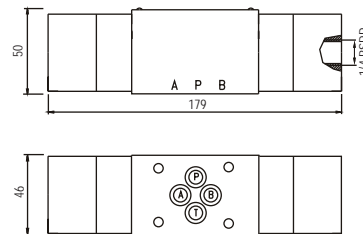

Pneumatic Operated Valves: Cetop 5, Flow 140 LPM, Pressure 320 Bar

Part Number & Pricing		Specifications	
Cetop 5	List Price	Schematic	Weight Kg
RH10016FNM	\$ 525		4.3
RH10026FNM	\$ 525		4.3

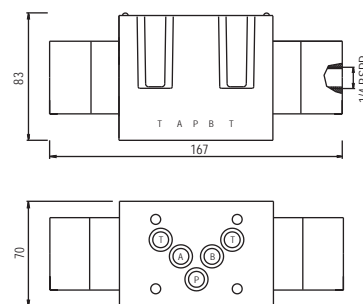

Hydraulic Operated Valves: Cetop 3, Flow 60 LPM, Pressure 320 Bar

Part Number & Pricing		Specifications	
Cetop 3	List Price	Schematic	Weight Kg
RH06012F	\$ 420		2.2
RH06042F	\$ 420		2.2
RH06022F	\$ 420		2.2
RH06002F	\$ 420		2.2
RH06112F	\$ 350		1.6

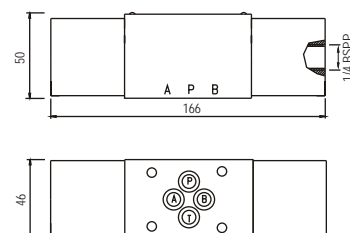

CETOP MODULAR VALVES SANDWICH DESIGN



Flow Control Valves: Pressure 320 Bar

Part Number & Pricing		Specifications			
Part.	List Price	Size	Function	Schematic	Weight Kg
DROK6M/32AB	\$ 190	Cetop 3	Meter In/Out (Universal)		0.8
DROK10M/32AB	\$ 240	Cetop 5	Meter In/Out (Universal)		2.6

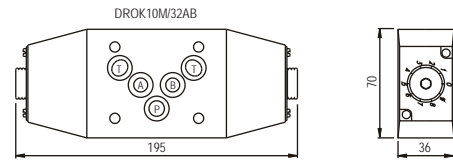
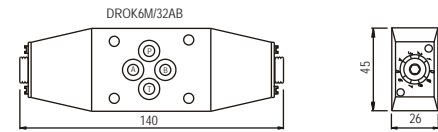

Relief Valves: Pressure 320 Bar

Part Number & Pricing		Specifications			
Part.	List Price	Size	Function	Schematic	Weight Kg
KP6M/32P	\$ 160	Cetop 3	P to T		1.1
KP6M/32AB	\$ 260	Cetop 3	A+B to T		1.3
KP6M/32AB2	\$ 260	Cetop 3	Crossline		1.3
KP10M/32P	\$ 190	Cetop 5	P to T		2.9

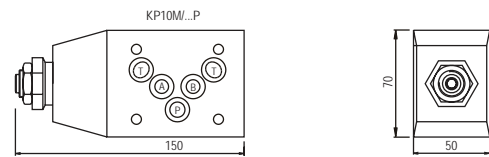
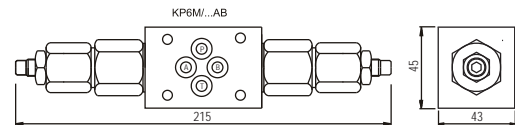

Reducing Valves: Pressure 320 Bar

Part Number & Pricing		Specifications			
Part.	List Price	Size	Function	Schematic	Weight Kg
MPR02-P-2-2	\$ 160	Cetop 3	70-8 bar		1.2
MPR02-P-2-4	\$ 160	Cetop 3	250-70 bar		1.2

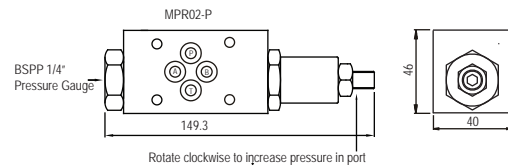

P/O Check Valves: Pressure 320 Bar

Part Number & Pricing		Specifications			
Part.	List Price	Size	Function	Schematic	Weight Kg
MPC-02-W-50	\$ 150	Cetop 3	Dual A & B		1.1
MPC-03-W-50	\$ 170	Cetop 5	Dual A & B		2

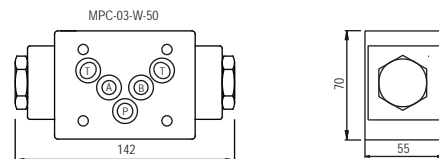
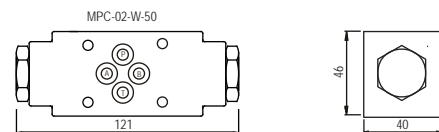

Overcentre Valves: Pressure 250 Bar

Part Number & Pricing		Specifications			
Part.	List Price	Size	Function	Schematic	Weight Kg
OWC6M/25A	\$ 190	Cetop 3	Single A		0.6
OWC6M/25AB	\$ 330	Cetop 3	Dual		0.9

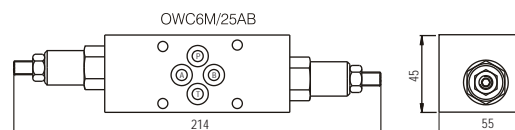

CETOP BAR MANIFOLDS



Cetop 3: Steel Manifolds

Parallel Design - Relief Option & Gauge Port

Part Number & Pricing		Specifications					
Part.	List Price	No. Stations	Ports - BSPP		Total Length mm	Dim "A" PCD mm	Weight Kg
			P & T	A & B			
HIC3P2SC	\$ 130	2 Station	1/2"	3/8"	120	108	4.5
HIC3P3SC	\$ 180	3 Station	1/2"	3/8"	170	158	6.2
HIC3P4SC	\$ 230	4 Station	1/2"	3/8"	220	208	8.2
HIC3P5SC	\$ 280	5 Station	1/2"	3/8"	270	258	10
HIC3P6SC	\$ 330	6 Station	1/2"	3/8"	320	308	12
HIC3P7SC	\$ 382	7 Station	1/2"	3/8"	370	358	14

Series Design - Relief Option & Gauge Port

Part Number & Pricing		Specifications					
Part.	List Price	No. Stations	Ports - BSPP		Total Length mm	Dim "A" PCD mm	Weight Kg
			P & T	A & B			
HIC3S2SC	\$ 160	2 Station	1/2"	3/8"	120	108	4.5
HIC3S3SC	\$ 220	3 Station	1/2"	3/8"	170	158	6.2
HIC3S4SC	\$ 280	4 Station	1/2"	3/8"	220	208	8.2

Cetop 3: Alloy Manifolds

Parallel Design - Relief Option & Gauge Port

Part Number & Pricing		Specifications					
Part.	List Price	No. Stations	Ports - BSPP		Total Length mm	Dim "A" PCD mm	Weight Kg
			P & T	A & B			
HIC3P2AC	\$ 150	2 Station	1/2"	3/8"	120	108	1.5
HIC3P3AC	\$ 210	3 Station	1/2"	3/8"	170	158	2.2
HIC3P4AC	\$ 270	4 Station	1/2"	3/8"	220	208	2.9
HIC3P5AC	\$ 330	5 Station	1/2"	3/8"	270	258	3.6
HIC3P6AC	\$ 400	6 Station	1/2"	3/8"	320	308	4.3

Series Design - Relief Option & Gauge Port

Part Number & Pricing		Specifications					
Part.	List Price	No. Stations	Ports - BSPP		Total Length mm	Dim "A" PCD mm	Weight Kg
			P & T	A & B			
HIC3S2AC	\$ 150	2 Station	1/2"	3/8"	120	108	1.5
HIC3S3AC	\$ 210	3 Station	1/2"	3/8"	170	158	2.2
HIC3S4AC	\$ 270	4 Station	1/2"	3/8"	220	208	2.9

Manifold Options

Part.	Description	List Price
R250	Relief Cartridge - Up to 250 bar	\$ 80
C3BP-P	Blanking Plate Parallel - All Ports Blocked	\$ 35

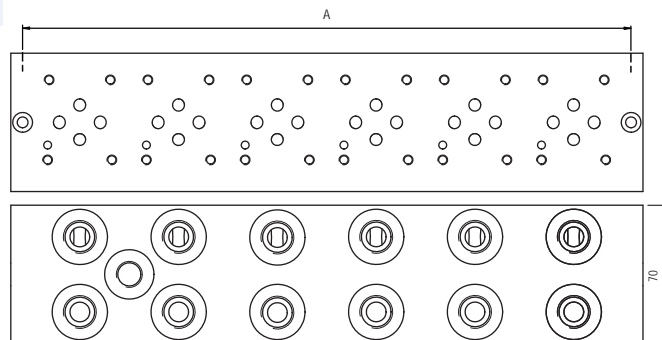

CETOP SUBPLATES

Cetop 3: Steel Subplates

Part Number & Pricing		Specifications	
Part.	List Price	Description	Weight Kg
G341/01	\$ 60	1/4" BSPP Bottom Entry	0.6
G342/01	\$ 60	3/8" BSPP Bottom Entry	1.1
G342/01-SE	\$ 60	3/8" BSPP Side Entry	0.7
C03/1-RV1	\$ 210	3/8" BSPP Side + Relief, Alloy	1.2

Top & Side Views - G342/01

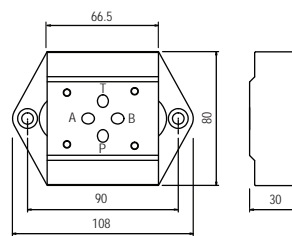

Top & Side Views - G342/01-SE

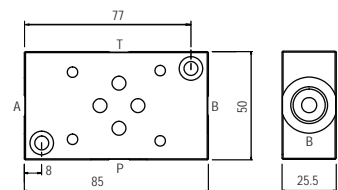

Cetop 5: Steel Subplates

Part Number & Pricing		Specifications	
Part.	List Price	Description	Weight Kg
G67/01	\$ 115	1/2" BSPP Bottom Entry	2
G67/01-SE	\$ 115	1/2" BSPP Side Entry	2.1

Top & Side Views - G67/01

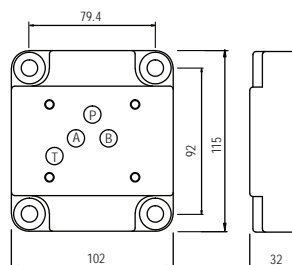

Top & Side Views - G67/01-SE

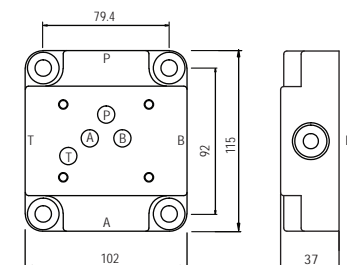

Cetop 7: Steel Subplates

Part Number & Pricing		Specifications	
Part.	List Price	Description	Weight Kg
G172/01	\$ 198	3/4" BSPP Bottom Entry	2.8
G174/01	\$ 275	1" BSPP Bottom Entry	9

QUICK HITCH KITS

QHD-VOLTAGE-REAR



2 Position Quick Hitch
Rear Entry Subplate

QHD-VOLTAGE-SE



2 Position Quick Hitch
Side Entry Subplate

QHD-VOLTAGE-TILT-REAR



3 Position Tilt
Rear Entry Subplate

QHD-VOLTAGE-TILT-SE



3 Position Tilt
Side Entry Subplate

**QHD-VOLTAGE-REAR
MPR02-P-2-2**



2 Position Quick Hitch
Pressure Reducing Valve
Rear Entry Subplate

**QHD-VOLTAGE-SE
MPR02-P-2-2**



2 Position Quick Hitch
Pressure Reducing Valve
Side Entry Subplate



Factory 19 / 5 Lyn Parade PRESTONS NSW 2170
Ph: (02) 9607 4100 Fax: (02) 9607 4200